

MR16 DownLights



Item Code:

MR16-438CA-30

4W cool white LED down light(MR16)12vAC/DC- 30° lens

MR16-438CA-60

4W cool white LED down light (MR16) 12vAC/DC - 40° lens

MR16-438WA-30

4W warm white LED down light (MR16) 12vAC/DC - 30° lens

MR16-438WA-60

4W warm white LED down light (MR16) 12vAC/DC - 40° lens

4w LED Down Light

FEATURES

- Only consumes 4 watts of power
- Similar light output of a 50w halogen
- Excellent heat dissipation
- Fits into most down light fittings
- Long Life Time - > 30,000 hrs
- Work with both electronic and iron core lighting transformers
- RoHS compliance



Technical Specifications

Model	MR16-438WA	MR16-438CA
Colour Temperature	2850-3200K	5650-6300K
Colour	Warm White	Cool White
Lumen	154 Lm	206 Lm
Housing	Aluminium	
Power Requirement	AC/DC 12V	
Power Consumption	4W	
Light Beam Angle	30, 60° options	
Working Temperature	-20°C ~ +60°C	
Working Humidity	10% ~ 90% RH	
Lifetime	> 30,000 Hrs	
Warranty	2 years	

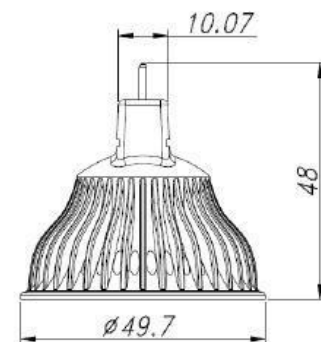
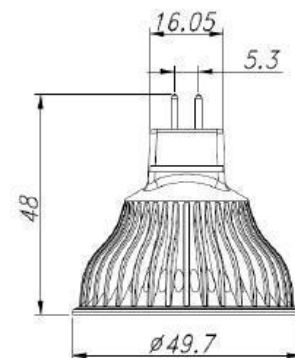

4w LED Down Light

30° Lens Data

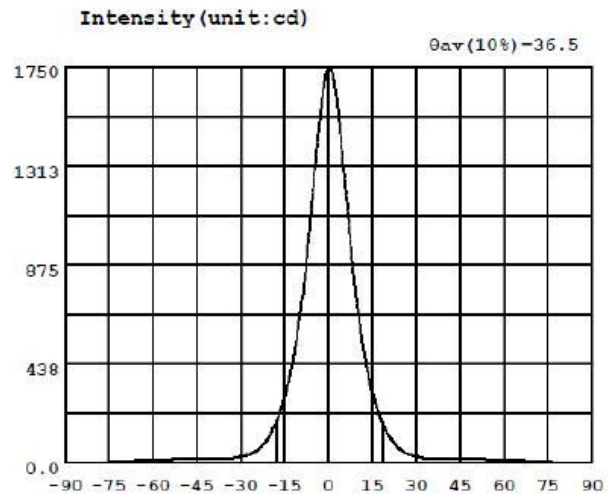
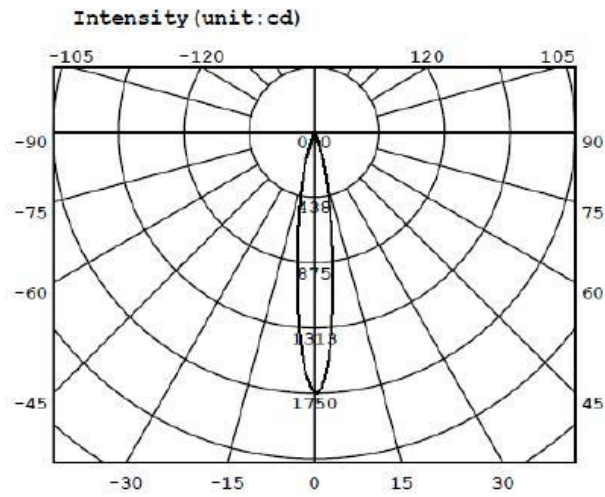

Average Illuminance Figure

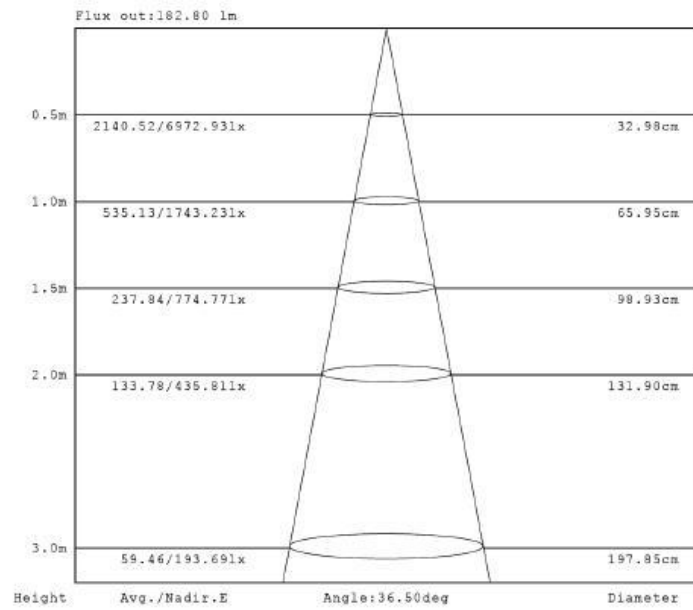

4w LED Down Light

60° Lens Data

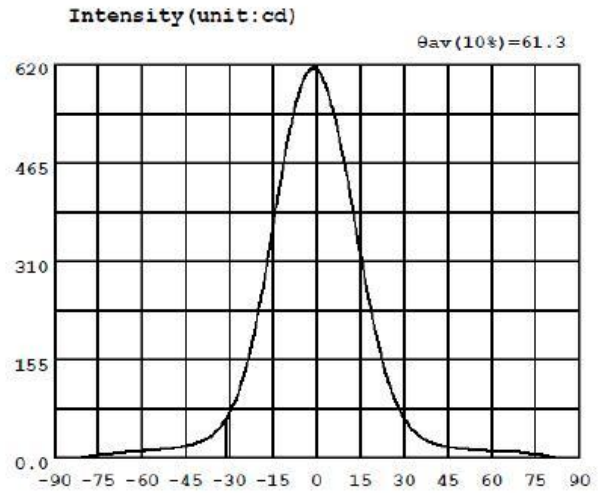
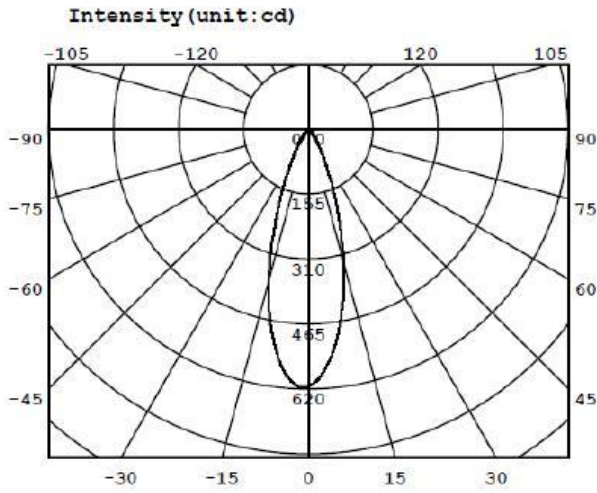

Average Illuminance Figure

